

Authorized Distributor for Bangladesh



HRG ENVIRONMENTAL ENGINEERING

(Ventilation Equipment Division)

Registered Office: Bagbari, 5 No. Ward, Kashimpur, Gazipur, Bangladesh

Dhaka Office: House # 41, Road # 12, Sector # 10, Uttara, Dhaka-1230

Mobile: +88 01713066638

E-mail: hasib@hrg.com.bd, **Website:** www.hrg.com.bd



FIYturn™ 飞腾

风机湿帘热风炉

智造专家

**Fan wet curtain hot blast
stove Smart experts**



公司简介 Company profile

中国山东青州飞腾温控机械有限公司是一家集温控通风系统和饲料输送系统专业制造、安装、售后服务于一体的高新科技环保型企业。

公司主要产品有畜牧风机、工业厂房专用风机、屋顶自动通风机等通风降温系列：湿帘、冷风机、水冷空调等室内降温系列；全自动热风炉、全（半）自动燃煤燃油热风炉、引风机、暖风炉、地源热泵、电磁锅炉等加温系列，空气输送、中央输送、料塔、料线等喂料系统。产品广泛用于农业、花卉业、畜牧业、纺织车间、厂房、化工、茶叶、烟草烘干、网吧、商场、超市、木材等行业。

我公司本着“以质量求生存，以信誉求发展”的经营理念，以卓越的品质、一流的服务不断开拓进取，为客户提供最优质的产品 & 售后服务。

您的满意是我们永恒的追求.....

Our factory QINGZHOU FEITENG THERMO-CONTROL MACHINERY CO.,LTD, established in March,2011,located in Qingzhou city, Shandong province ,China .It's with QINGZHOU GOOD-VALUE IMPORT AND EXPORT CO.,LTD Belongs to same company.We are a professional temperature company who is design, manufacture, sales, installation and after-sale service in the integration of high-tech environmental production enterprises.

The main products of our company are animal husbandry and fan, industrial workshop special fan, roof automatic fan ect ventilation cooling series: Wet curtain, cooling pad, water-cooled air conditioning indoor temperature series, automatic hot air stove, all(half) automatic coal fuel stove, exhaust-er, warm wind stove and so on heating series, Air transport, central transport, feed tower, feed line and other feeding systems.The products are widly used in agriculture, flower, animal husbandry, textile workshop, chemical, internet bar, wood ect.

Our company has the management idea which is that quality seek survival, prestige seek development by the high quality products and excellent services continue to forge ahead, to provide customers with the best quality, lowest price products and after-sales service.

有位先贤曾说过；治国必先齐家，齐家必先修身，修身者，做人也。不会做人，便不会做生意，刁钻狡诈之人，虽得一时蝇利，终究难成大器。“无奸不商”之观念，培养了一代又一代小商小贩，中华商界，几千年来鲜见巨商大贾。吾辈不才，但先贤之遗训不敢一日忘却。利，我所欲也？义，我所欲也？两者不可兼得，舍利而取义也，舍小利而取大义，是为大利。大利者，利天下，利众生，而吾利亦在其中矣。商界学步十载，我飞腾公司苦练为人之道，以忠厚交朋友，以信义取市场，虽经几番恶风狂雨，但赖朋友扶助，赖民众厚爱，步履反倒越发稳健迅捷，抖落风雨，踏平坎坷，眼前似乎处处是路，而且，路路皆坦途。飞腾公司由此雄视天下！然而，举目四望，我辈焉敢耽于安乐！海内外英俊辈出，超出我辈者，如星月在天。见贤思齐，见贤思超，这是飞腾人的性格！

企业资质 Enterprise qualification



企业荣誉 Enterprise Honor



FT-C 离心推拉式风机 FT-C Centrifugal push-pull Exhaust Fan



● 风扇叶片是由克虏伯不锈钢冲压成型，无灰尘，美观耐用。特殊的叶片形状设计保证风量大，不变形，不断裂，使空气体积相同的所有方式。

Fan blade is made of Krupp stainless steel by punch forming, no dust, attractive and durable. Special blades shape design ensure large air volume, no deformation, no broken, keep air volume same all the way.

● 中国著名的电机与西门子电机可用。电机的电压和频率可定制。中国著名的汽车用特殊设计的风扇，第一个提出在缺相保护装置，关闭电源，当电力短缺，可自行断电。电机防护等级IP 55，绝缘等级F。

Both Chinese famous motor and Siemens motor are available. Motor voltage and frequency could be customized. Chinese famous motor, special design for fan, the first one put forward the phase lack protection device which could power off when shortage of electricity. Motor protection grade IP55, insulation Class: Grade F

● 风扇皮带轮是由高强度铝镁合金的压铸，降低重量，叶轮叶片完整，高耐蚀性。加强筋带轮设计。消除内部应力，提高自身的刚度和稳定性，不会破碎。

Fan belt pulley is made of high strength aluminum-magnesium alloy by die-casting which reduces the weight of blade impeller complete, high corrosion resistance. Special three reinforced ribs pulley design. Blast-sanding treatment for attractive appearance, eliminate internal stress to improve its own rigidity and stability, never broken.

● 风扇轴承采用双列轴承专用防水设计，水不能进入。强度高，噪音低，免维护，使用寿命长。

Fan bearing adopts imported double-row bearing with special waterproof design, water can't enter. High strength, lower noise, maintenance free and long service life.

● 推拉机构能完全打开百叶窗，保证了最小的空气阻力和最大风量。当关闭时，能有效的防风、防雨、防尘。采用优质尼龙100%原料注塑加工。紧固件推拉机构都是铜铆钉，耐磨、不生锈，灵活。导杆使用了304不锈钢，确保了高强度，不生锈，减少摩擦。

Centrifugal system open the shutters at complete 90 degree to ensure the lowest air resistance and biggest air volume. when closed, the sealing can efficiently block light and wind into the poultry farm house. As the first one adopts high quality nylon 100% to ensure the long service life. The fasteners of centrifugal system all are copper rivets, wear-resisting and no rust, flexible. Guide rod is made of 304 stainless steel, ensuring the high strength, no rust, reduces friction.

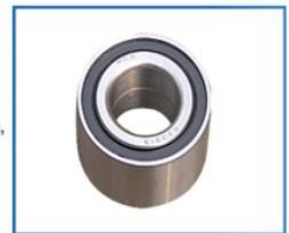

主要技术参数: Technical parameter:

型号规格 Model specifications	风叶直径 Diameter blades (mm)	频率 Frequency (Hz)	电机转速 (转/分) Motor rotational speed rpm	风量 Air flow (m ³ /h)	输入功率 (W) Import power	噪音 (分贝) Noise decibels	额定电压 (V) Rated voltage	高 (mm) Height	宽 (mm) Width	厚 (mm) Thickness
FT-900	900(24in)	50	≥1400	35000	750	≤70	380	1000	1000	450
FT-1000	1000(36in)	50	≥1400	38000	750	≤64	380	1100	1100	450
FT-1270	1270(50in)	50	≥1400	48000	1100	≤64	380	1380	1380	450
FT-1400	1400(56in)	50	≥1400	55800	1500	≤64	380	1530	1530	450

由于产品不断更新，技术参数如有改动恕不另行通知。

外形尺寸 Outline dimensions

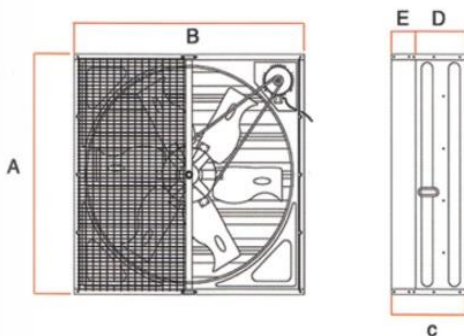

注: E 区为检修扣板, 严禁埋入墙体!
Note: Ezone for maintenance, Embed wall forbidden.



- 风机采用铝合金拉杆重量轻, 不变形; 拉杆上加有耐磨滑套, 有效提高配合间隙, 降低摩擦系数, 确保百叶窗开启灵活; 拉簧采用优质 304 不锈钢制成, 长期使用不变形、不生锈;
- Linking parts made of aluminum alloy, light weight, not deformation, and with wear-resistant shaft sleeve, reduce clearance, then reduce frication to ensure the shutters open flexibly. The spring is made of 304 stainless steel, long time use, no deformation, no rust.



- 风机垫圈均采用不锈钢制成, 外观漂亮。不生锈;
- Standard parts especially the washer as fastener parts are made of stainless steel, no rust, beautiful appearance.



- 电机挂板采用独特设计, 具有多功能性, 可根据客户需求安装 1HP 或 1.5HP 电机, 均确保电机皮带轮与扇叶皮带轮在同一直线上, 有效减少三角带磨损, 保障皮带使用更长久;
- Motor plate has multiple function with the use of a unique design. Both 1HP and 1.5HP motor are available. The motor pulley and belt pulley in the same line in order to reduce the belt wearing and increase belt service life.



- 风机扇叶均经过先进的电脑动平衡测试仪校正。动平衡量控制在 1g 之内, 使用风机运行平稳、振动小、噪音小、增强整机稳定性, 扇叶材质可用不锈钢、镀锌板、铝合金制造;
- Fan blades are adjusted by intelligent dynamic-balance tester, each blade tolerance weight controlled within 1g. Ensure the fan smooth running, lower vibration, less noise, increase stability. Blade material have stainless steel, galvanized sheet, aluminum alloy for option.



- 风机采用热镀锌立柱、热镀锌保护网, 保证今后使用过程中不生锈;
- Hot-dip galvanized blade support and safe net ensure never rust.



- 风机完全改为数控流水化生产, 准确掌握产品质量, 达到国际同行业的最高水平, 外观美观。
- Complete new CNC production line improved fan quality up to top grade, aesthetic appearance.

风机型号 Fan model	噪音 Noise 在 7 米距离 (dB) at 7m distance	尺寸 Dimension (mm)					
		A	B	C	D	E	F
FT -600(24-)	69	750	750	510	370	140	620
FT -910(36-)	67	1000	1000	450	305	145	935
FT -1270(50-)	59	1380	1380	450	305	145	1290

● 安装示意图 Installation diagram

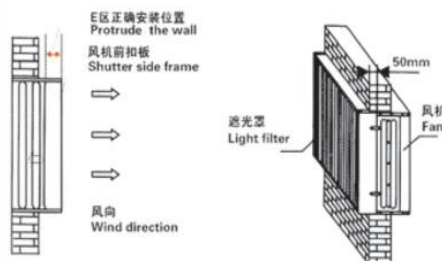

风机流量曲线图 Air Flow Curve

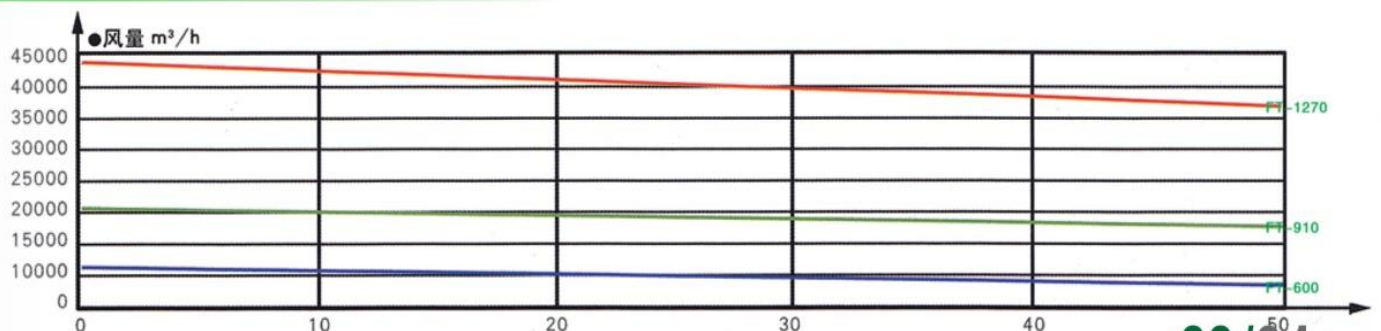

FT-B 重锤式风机 FT-B Dorp Hammer Exhaust Fan

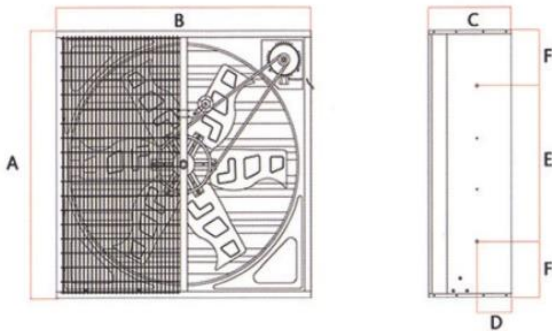

外形尺寸 Outline dimensions

风机型号 Fan model	噪音 Noise 在7米距离 (dB) at 7m distance	尺寸 Dimension (mm)					
		A	B	C	D	E	F
FT-620 (20")	68	620	620	400	237	520	50
FT-750 (24")	69	750	750	450	84	474	138
FT-780-2 (24")	69	780	780	420	237	400	190
FT-780 (24")	65	780	780	400	133	400	190
FT-830 (28")	64	830	830	400	133	400	215
FT-900 (30")	64	900	900	400	133	400	250
FT-1000 (35")	65	1000	1000	400	133	500	250
FT-1060 (39")	65	1060	1060	400	133	660	200
FT-1100 (40")	64	1100	1100	400	133	460	320
FT-1220 (43")	62	1220	1220	400	133	705	257
FT-1380 (50")	60	1380	1380	400	133	1000	190
FT-1530 (55")	59	1530	1530	400	133	900	315

● 风机流量曲线图 Air Flow Curve

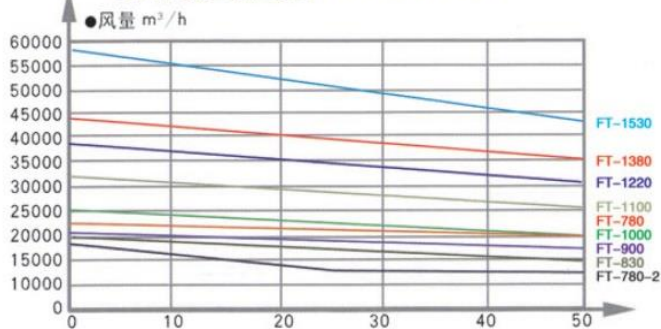

主要技术参数: Technical parameter:

型号规格 Model specifications	风叶直径 Diameter blades (mm)	风叶转速 (转/分) Blades rotational speed rpm	电机转速 (转/分) Motor rotational speed rpm	风量 Air flow (m³/h)	全压 (Pa) Total pressure	噪音 (分贝) Noise decibels	输入功率 (W) Import power	额定电压 (V) Rated voltage	高 (mm) Height	宽 (mm) Width	厚 (mm) Thickness
FT-500(20")	500	1400	1400	5700	55	≤70	370	380	600	600	400
FT-710(29")	710	660	1400	22000	60	≤60	370	380	800	800	400
FT-750(30")	750	630	1400	28000	65	≤65	550	380	900	900	400
FT-900(36")	900	610	1400	30000	70	≤70	750	380	1000	1000	400
FT-1000(40")	1000	600	1400	32500	70	≤70	750	380	1100	1100	400
FT-1100(44")	1100	460	1400	38000	73	≤70	1100	380	1220	1220	400
FT-1250(50")	1250	439	1400	44000	56	≤75	1100	380	1380	1380	400
FT-1400(56")	1400	325	1400	55800	60	≤70	1500	380	1530	1530	400



- 采用热镀锌立柱、热镀锌保护网，保证今后使用过程中不生锈。
- Hot-dip galvanized blade support and safe net ensure never rust.

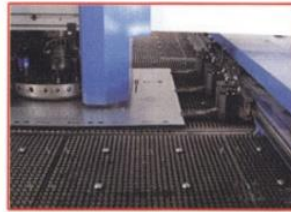

- 风机完全改为数控流水线生产，准确掌握产品质量，达到国际同行业的最高水平，外形美观。
- Complete new CNC production line improved fan quality up to top grade,aesthetic appearance.



- 扇叶采用克虏伯自洁不锈钢材料经模具冲压成型制成，不挂灰、外形美观；特殊加强风扇形状设计，风量大、不变形、不断裂、风量始终如一；不锈钢厚度：1.2mm、表面光洁度：BA

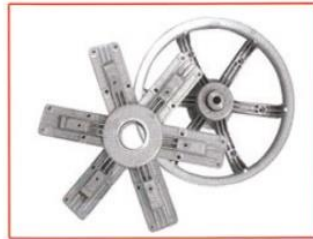

- 皮带轮均采用高强度铝镁合金压铸制成，重量轻，耐腐蚀性能强，减轻扇叶重量；特殊三根加强筋皮带轮设计，表面经过喷砂处理，提高美观度，消除内应力，有效提高自身强度，永无断裂。
- Fan belt pulley is made of high strength aluminum-magnesium alloy by die-casting which reduce the weight of blade impeller complete, high corrosion resistance.Special three reinforced ribs pulley design. Blast-sanding treatment for attractive appearance,eliminate internal stress to improve its own rigidity and stability,never broken.



- 电机有国产名牌和西门子电机供客户选择，可根据客户需要电压、频率定制；国产电机首家加入缺相保护装置，当电源缺相时进行断电控制；电机均采用防护等级：IP55、绝缘等级：F级；
- Both China famous motor and Siemens motor are available, Motor voltage and frequency can be customized.Chinese famous motor OEM by special design for fan,the first put in the phase lack protection device which would power off when shortage of electricity.Motor protection grade IP55,insulation class F grade.



- 风机扇叶均经过现金的电脑动平衡测试仪校正，动平衡量控制在1g之内，使用风机运行平稳、振动小、噪音小、增强整机稳定性，扇叶材质可用不锈钢、镀锌板、铝合金或塑钢。
- Fan blades are adjusted by intelligent dynamic-balance tester,each blade tolerance weight controlled within 1g.Ensure the fan smooth running,lower vibration,less noise,increase stability. Blade material have stainless stell,galvanized sheet,aluminum alloy,FRP for option.



- 风机轴承均采用法国进口双列轴承，特殊的防水设计，使水不能进入轴承，轻度高、噪音小、寿命长、免维护。
- Fan bearing adopts imported double-row bearing with special waterproof design,water can't enter,High strength,lower noise,maintenance free and long service life.



- 采用高强度尼龙摆锤重锤打开机构，保证百叶窗打开，关闭灵活；
- Using high strength nylon swung drop hammer opening device to ensure the shutters opening and closing flexibly.



- 皮带采用日本进口三星皮带，确保使用寿命，免维护。
- Belts are Japanese Mitsubishi brand,ensure the long service life,maintenance free.



- 风机均采用最先进皮带自动涨紧装置，提高传动效率，保证皮带良好运行。
- Using the most advanced automatic belt tensioner to ensure working efficiency and good performance.

FT-G 悬挂式风机 FT-G Hanging Exhaust Fan



- 风机均采用热镀锌立柱、热镀锌保护网，保证今后使用过程中不生锈；并提高标准档次，使其不生锈。
- Hot-dip galvanized blade support and safe net ensure never rust.



- 风机加有 4 个吊装环，方便按装，可任意调节风机角度，使风机达到良好吹风效果；
- Fan frame with 4 hoist rings, convenient for installation and angle adjustment, ensure excellent performance.



- 皮带采用日本进口三星皮带，确保使用寿命，免维护。
- Belts are Japanese Mitsubishi brand, ensure the long service life, maintenance free.

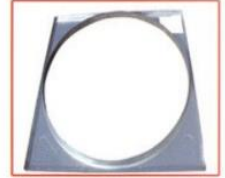

- 风机导流罩采用镀锌层 180 克/平方，正价了镀锌层厚度，保证今后使用不生锈；
- Fan galvanized round frame with zinc-coated of 180g/sqm, increase zinc-coated layer, to ensure never rust.

主要技术参数：Technical parameter:

型号规格 Model specifications	风叶直径 Diameter blades (mm)	风叶/片 Wind leaf /piece	额定电压 Rated voltage (V)	级数 Pole	风叶转速 Motor rotational speed r/min	输入功率 Input power (W)	风量 Air flow (m ³ /h)	高 Height (mm)	宽 Width (mm)	厚 Thickness (mm)
FT-1000	1000	4	380	8	700	400	25560	1140	1140	300
FT-1100	1100	6	380	10	540	750	38000	1220	1220	350

由于产品不断改进，各种参数如有变动，恕不另行通知。



- 扇叶采用克虏伯自洁不锈钢材料经模具冲压成型制成，不挂灰、外形美观；特殊加强风扇形状设计，风量大、不变形、不断裂、风量始终如一；不锈钢厚度：1.2mm，表面光洁度：BA

- Fan blade is made of Krupp stainless steel by punch forming, no dust, attractive and durable. Special blades shape design ensure large air volume, no deformation, no broken, keep air volume same all the way. Thickness 1.2mm, surface finish BA grade.

- 扇叶均经过现金的电脑动平衡测试仪校正，使风机运行平稳、降低噪音、增强稳定性、延长使用寿命。

- Fan blades are adjusted by intelligent dynamic-balance tester, ensure the fan smooth running, lower vibration, less noise, increase stability and service life.

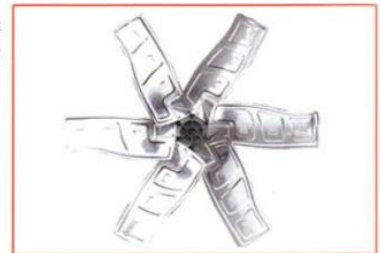

主要技术参数：Technical parameter:

型号规格 Model specifications	风叶直径 Diameter blades (mm)	风叶转速 (转/分) Blades rotational speed (rpm)	风叶/片 Wind leaf /piece	风量 Air flow (m ³ /h)	全压 Total pressure (Pa)	噪音分贝 Noise decibels (dB)	输入功率 Input power (W)	额定电压 Rated voltage (V)	高 Height (mm)	宽 Width (mm)	厚 Thickness (mm)
FT-900	900	540	6	23000	56	≤60	550	380	1000	1000	300
FT-1000	1000	540	6	32500	56	≤60	550	380	1100	1100	300
FT-1100	1100	540	6	38000	56	≤60	750	380	1220	1220	350

由于产品不断改进，各种参数如有变动，恕不另行通知。

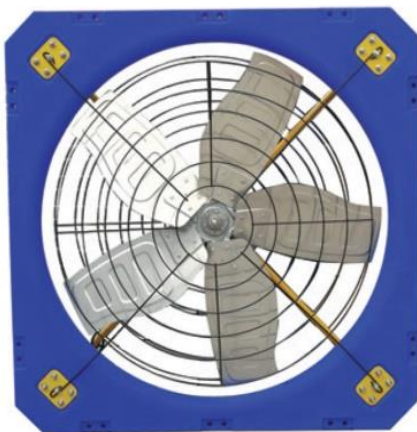
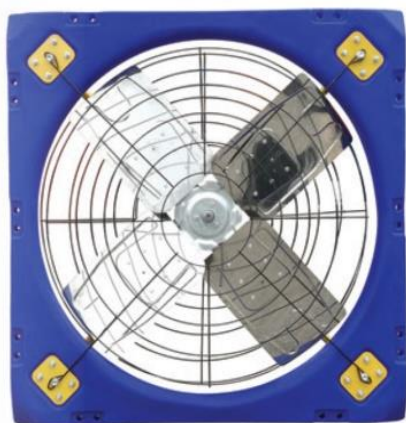

● 风机完全改为数控流水化生产，准确掌握产品质量，达到国际同行业的最高水平，外形美观。

● Complete new CNC production line improved fan quality up to top grade, aesthetic appearance.

● 风机流量曲线图 Air Flow Curve

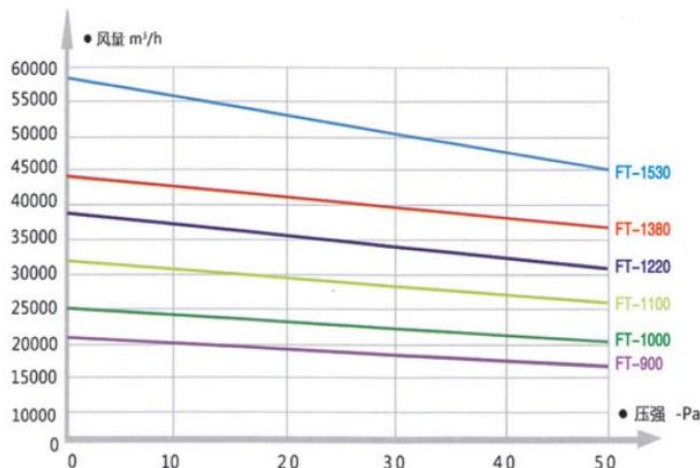

主要技术参数: Technical parameter:

型号规格 Model specifications	风叶直径 Diameter blades (mm)	风叶/片 Wind leaf /piece	额定电压 Rated voltage (V)	级数 Pole	风叶转速 Motor rotational speed r/min	输入功率 Input power (W)	风量 Air flow (m³/h)	高 Height (mm)	宽 Width (mm)	厚 Thickness (mm)
FT-1100	1000	4	380	8	680	450	30000	1100	1100	350
FT-1240	1100	5	380	8	680	550	35000	1240	1240	350

由于产品不断改进，各种参数如有变动，恕不另行通知。

FT-E 双门式拢风筒风机 FT-E Double-door Cone Fan(Butterfly Cone Fan)



双门关闭 Close



双门打开 Open

●采用先进前置双门打开机构,风阻小、密封好、效率高;加长喇叭口设计,提高抽风压力。

●Using advanced front double door opening device,small wind resistance,good sealing,high efficiency,lengthened cone design improve exhaust power.

●外框镀锌板均采用 180/m² 镀锌层,有效避免生锈。

●Galvanized steel frame is made of 180/m² galvanized layer,avoid rust.

●风机双门关闭时加有橡胶密封装置,当多台风机根本环境情况,不同时启动时,有效避免空气回流,大大提高运行效率,与同功率风机相比,提高效率 15-25%;

●Fan double doors closed with the rubber sealing which effectively avoid air backflow when start fans at different time.Greatly improve the operation efficiency by 15-20%compared with the same power fan.

●风机特殊的风扇形状设计使其可自行清洁以达到最高效率,扇叶采用克虏伯自洁不锈钢材料模具冲压成型制成,风量大,不变形、不断裂、不挂灰、美观耐用;不锈钢厚度:1.2mm、表面光洁度:BA。

●Fan fan blade is special designed for top grade efficiency which made of Drupp stainless steel by punch forming.Large air volume,no deformation,no broken,no dust,attactive and durable.Thickness 1.2mm,surface finish BA grade.

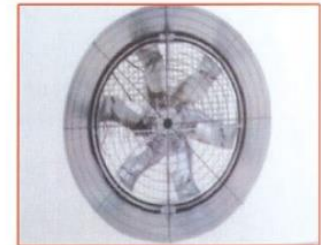
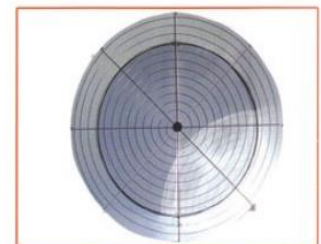

主要技术参数: Technical parameter:

型号规格 Model specifications	传动方式 drive	风叶直径 Diameter blades (mm)	风叶转速 (转/分) Blades rotational speedrpm	电机转速 (转/分) Blades rotational speedrpm	风量 Air flow m/h	全压 Pa Total pressure	噪音分贝 Noise decibels	输入功率 (W) Input power	额定电压 (V) Rated voltage	高 mm High	宽 mm Width	厚 mm Thickness
FT-900	皮带 Belt	750	630	1400	24000	65	≤65	370	380	900	900	930
FT-1100	皮带 Belt	1000	600	1400	36000	70	≤65	750	380	1100	1100	1150
FT-1220	皮带 Belt	1100	460	1400	41000	73	≤65	750	380	1220	1220	1200
FT-1380	皮带 Belt	1270	439	1400	51020	80	≤65	1100	380	1380	1380	1300

FT-冷风机 FT Air cooler



产品实图



内部结构图

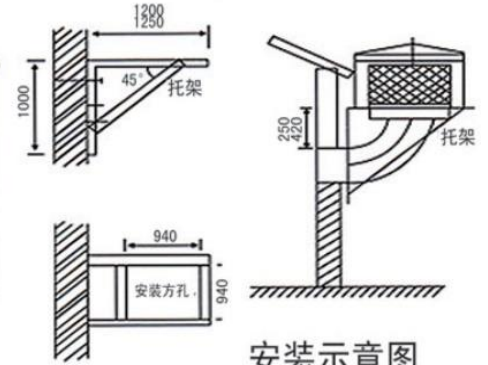

安装示意图

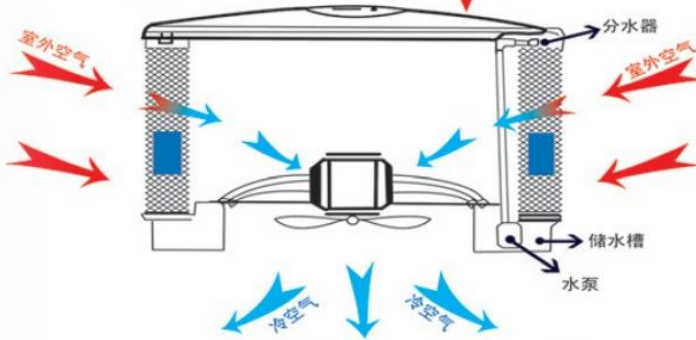

主要技术参数: Technical parameter:

型号	FT-环保水冷空调	FT-环保水冷空调
出风形式	上/下/侧	上/下/侧
功率	1.1kw/1.5kw	2.2kw/3.0kw
风量 (m ³ /h)	18000/20000	25000/30000
风叶类型	轴流	轴流
电压	3Phase380V/220V	3Phase380V
频率	50/60HZ	50HZ
控制系统	单速控制/变频控制	单速控制
尺寸 (m)	1.1*1.1*0.9m	1.1*1.1*1.15m
风压	180Pa	180Pa
适用面积	80-150m ²	200-350m ²
噪音	≤70DB	≤70DB
储水量	30L	30L
耗水量	10-15L/h	15-25L/h
重量	60KG	80KG
出风口尺寸	670*670mm	670*670mm
水帘尺寸	660*770*100mm	660*770*100mm

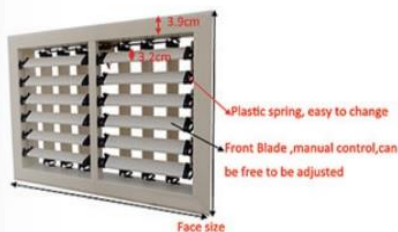

FT- 高强度湿帘 FT High Intensity Cooling pad

性能特点: Performance characteristics:

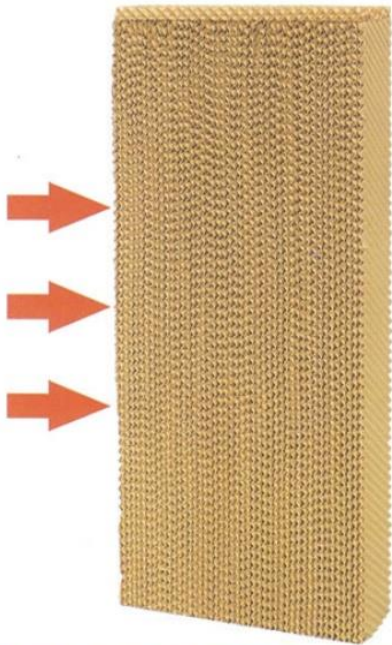

- 湿帘采用新材料与空间交联技术, 高吸收、高耐水、抗霉变、耐腐蚀、使用寿命长;
- 产品蒸发面积大, 降温效率达 80% 以上;
- 产品含表面活性剂, 自然吸收扩散速度快, 效能持久; 一滴水 4-5 秒钟即可扩散完毕, 自然吸收高度 60-70mm/5 分、200mm/1.5 时, 完全达到国家同行业标准。
- 产品不含易使皮肤过敏的苯酚等化学物质, 安装使用时对人体无毒无害, 安全、节能、环保、经济适用;
- 多种外表颜色: 棕色、绿色、棕绿交错色、单面黑色(可清洗)、单面绿色(可清洗)、单面黄色(可清洗)
- 严格按照标准制定生产, 600mm 宽度湿帘纸张数量 85 张左右; 原材料采用进口牛皮纸、定量 105g/m²、抗张力 70N、厚度 0.18-0.20 mm、吸水高度 45mm/10min、水分 5-8%、湿强度 18N;
- Use the new material and the space crossing linking technology, high absorbability, high water-resistant, anti-mildew and long service life
- Large evaporative area, cooling efficiency as high as 80%
- The product contains surface active agent, natural water absorbability, fast pervasion speed, lasting effectiveness. A drop of water can diffuse in 4-5 seconds. Height of absorb :60-70mm/5 minutes, 200mm/1.5 hours ,can achieve international standard.
- The products don't contain phenol which easy to skin allergy and other chemical substances, when installed non-toxic harmless to human body, safety, energy saving, environment protection and economic applicable
- Various color : Brown、 Green、 Green&Brown colour、 One side Black-coated colour (washable)、 One side Green-coated colour(washable)、 One side Yellow-coated colour (washable)
- Strict production as per standard, width of 600mm cooling pad involves 85 sheets; raw material adopt imported kraft paper(100GSM, thickness:0.18-0.20mm, tension resistance

湿帘片结构说明: Specification of cooling pad

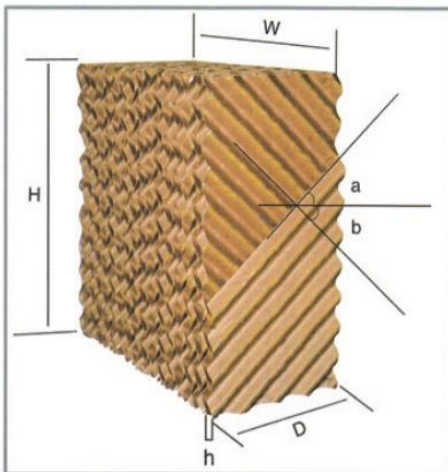

	7090型(model)	7060型(model)	5090型(model)
H(mm)	1500.1800.2000	1500.1800.2000	根据客户要求定做 Custom-made by client' requirements
W(mm)	900.600.300	900.600.300	根据客户要求定做 Custom-made by client' requirements
T(mm)	100.150.200	100.150.200	根据客户要求定做 Custom-made by client' requirements
h(mm)	7	7	5
a(°)	45	45	45
b(°)	45	15	45

- H:湿帘高度 Height of pad
- h:湿帘波纹高度 height of flute
- a:波纹角度 Angle of flute

- W:湿帘宽度 Width of pad
- D:湿帘厚度 Thickness of pad
- b:波纹角度 Angle of flute

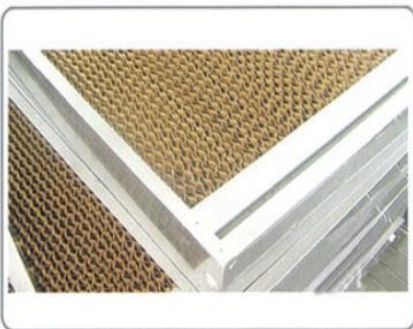

镀锌板外框湿帘

Assembled cooling pad with GS frame

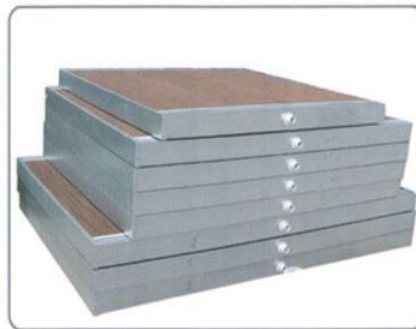

不锈钢外框湿帘

Assembled cooling pad with SS frame

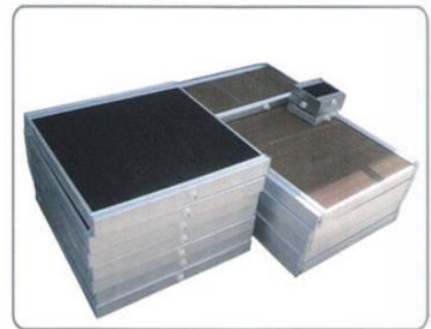

铝合金外框湿帘

Assembled cooling pad with AL frame

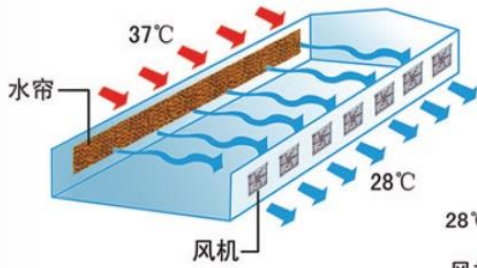

横向水帘降温系统

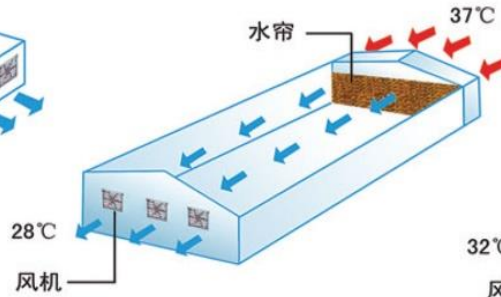

纵向水帘降温系统

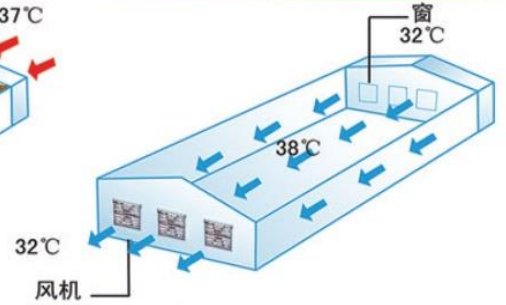

负压抽风机

● 框架结构

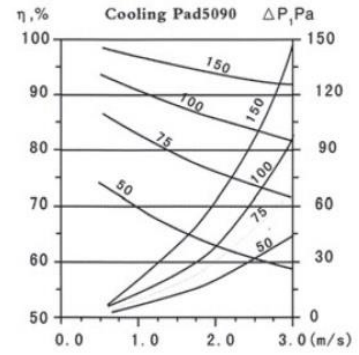
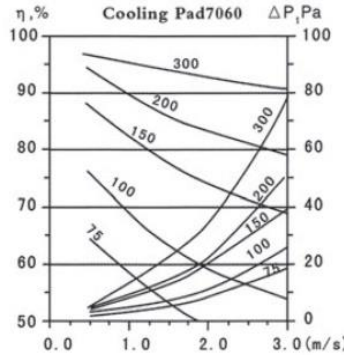
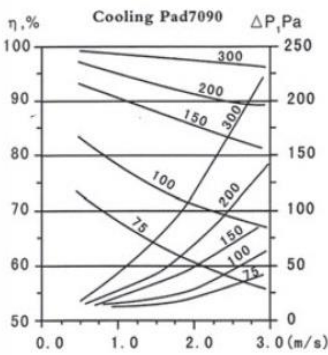

湿帘安装示意图: installation diagram

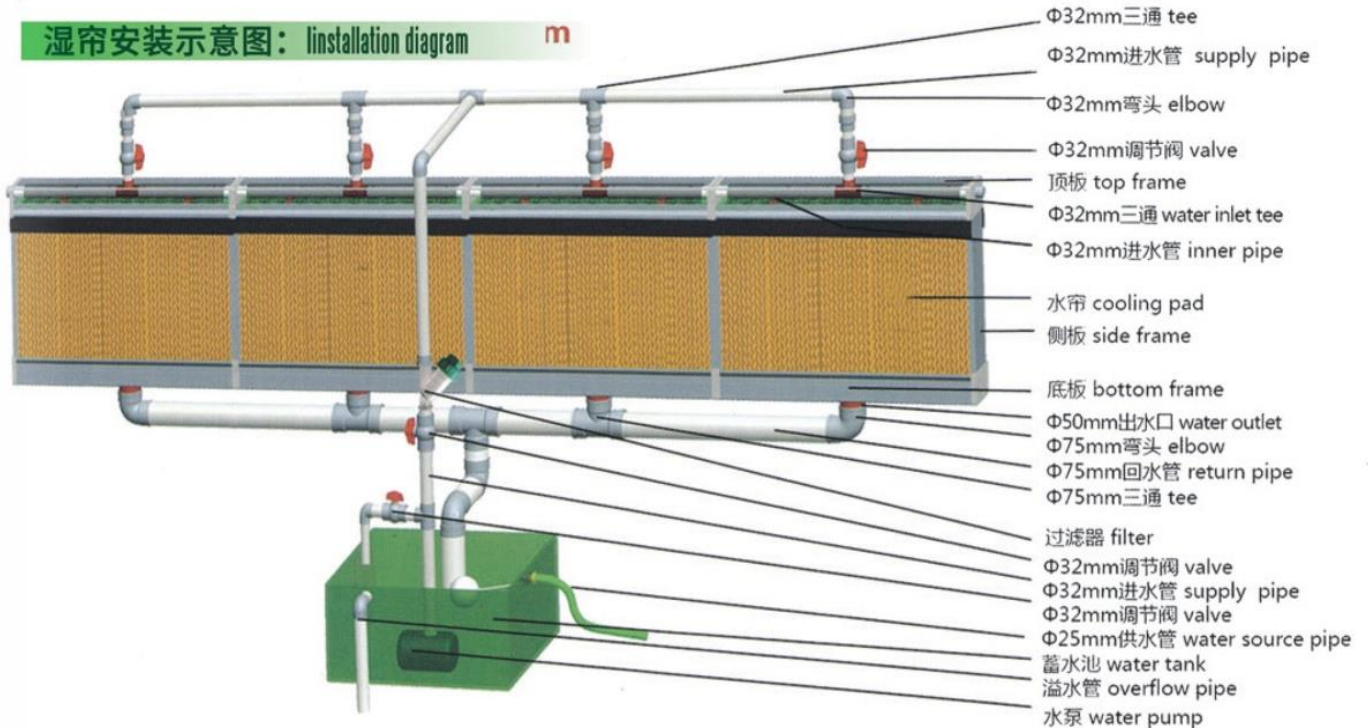

FT-D 玻璃钢风机 FT-D Glass steel Exhaust Fan



性能特点: Performance characteristics:

- 1、合理的喇叭口设计, 噪音低、风量大、抽风力强、运转费用低;
- 2、进口轴承, 强度高、噪音小、持久耐用;
- 3、采用空气顺流原理合成式PVC百叶窗或铝板百叶窗, 抗氧化、重量、不变形、开启灵活、防空气倒流;
- 4、高强度多加强筋铝镁合金皮带轮, 重量轻、强度高、韧性好;
- 5、有垂直式和倾斜式两种风机, 有效满足不同场地的需求。

1. The bell design reasonable, low noise, large air volume, strong ventilation, low running cost;
2. The imported bearings, high strength, low noise, durable;
3. The air downstream principle, synthetic PVC shutters or aluminum shutter, antioxidant, weight, no deformation, flexible opening, to prevent reverse flow of air;
4. The high strength reinforced aluminum magnesium alloy wheel, light weight, high strength, good toughness;
5. We have vertical and inclined two kinds of fan, effectively meet the needs of different venues.

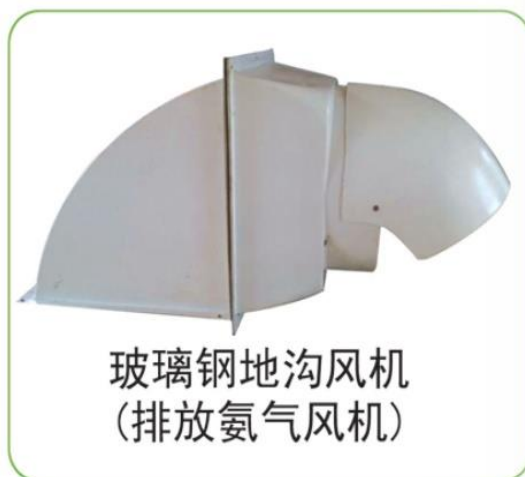

安装实例: Installation example:



主要技术参数: Technical parameter:

规格型号 Model	扇叶直径 Propeller Dia. Mm/(Inch)	扇叶数量	扇叶材质 Propeller Material	额定转速 Rated Speed (R/min)	风量 Air Capacity M ³ /h/(CFM)	额定功率 Rated Power KW/HHP	噪音 Noise Db	电压参数 Voltage Frequency/Phase	尺寸 Complete Size LXHXW(mm)	带喇叭口尺寸 Size With Cone LXHXW(mm)
FTD-1460	1260(50")	6	玻璃钢 fiberglass	520	44000(26000)	0.75-10	60-70	380V/220V	1460*1460*590	1460*1460*1270
FTD-1260	1080(43")			520	40000(23500)	0.55-10	60-70	50HZ/60HZ	1260*1260*560	1260*1260*1200
FTD-1060	890(36")			520	28000(16600)	0.37-8	60-70	3/1	1060*1060*560	1060*1060*1160
FTD-850	640(25")			700	13000(7700)	0.37-6	60-70		850*850*450	850*850*950
FTD-660	480(19")			950	10000(4100)	0.37-6	60-70		660*660*450	
FTD-560	380(15")			950	8000(3000)		60-70		560*560*450	

FT- 新式高效玻璃钢风机 FRP Fan blade fan



传动系统



降噪专用铝扇叶



高效电机

此款玻璃钢风机适用于有腐蚀性气体的养猪场、养鸡场。玻璃纤维外壳极其坚固且抗腐蚀、不变形、不掉色。喇叭形排风口高度耐冲击，提高性能10%铸铝扇叶采用失锯齿状设计，可有效降低噪音并增加气流量，提高效率。高质量进口轴承，确保扇叶平稳高效运转，可润滑汽车型皮带张紧器。

主要技术参数: Technical parameter:

规格型号 Model	风机尺寸 Inch	扇叶直径 Propeller Dia. (MM)	扇叶 (Blade)	扇叶转速	风量	额定功率	电压参数 Voltage Frequency/Phase	驱动方式 Drive Mode	风机尺寸	洞口尺寸	
				Rated Speed (R/min)	Air Capacity M ³ /h/(CFM) @0"SP	Rated Power Kw			Complete Size LXH(mm)	LXH(mm)	
FT-1530	51	1290	3片铸铝扇叶 3 Aluminum blade	600	46000(27075)	1.1	380V/220V 50HZ/60HZ	皮带 Belt	1530*1530*1220	1460*1460	
				646	47500(27957)	1.5			1530*1530*1220	1460*1460	
FT-1170	36	900	3片铸铝扇叶 3 Aluminum blade	850	22000(12950)	0.55			皮带 Belt	1170*1170*1200	1080*1080
				924	24500(14420)	0.75				1170*1170*1200	1080*1080
FT-810	24	650	4片铸铝扇叶	1400	12000(7062)	0.37			直驱 Direct	810*810*1000	730*730
FT-660	18	460	5片铸铝扇叶	1400	7400 (4350)	0.37			直驱 Direct	660*660*780	580*580

FRP ROOF TOP EXHAUST FAN



Product features:

The fan is made of fiberglass, scientific aerodynamic design and reasonable and beautiful structure, It is suitable for forced ventilation in workshop, grain depot, electric power, petroleum, chemical industry, metallurgy, stadium and other modern facilities

- ◆ Fan installed vertically on the roof, the mushroom wind and rain hat guarantee no wind and rain enter, the guide plate can reduce the loss of wind
- ◆ Thick and corrosion resistance shell by hand molding, Smooth surface without burrs
- ◆ SMC paddle blades, 3 blade
- ◆ Special custom-made aluminum shell direct drive motor, save maintain cost
- ◆ Hot galvanized steel protecting net or PVC shutter will be optional



技术参数 Technical Parameter:

规格型号 Model	扇叶直径 Propeller Dia. Mm/(Inch)	扇叶 fiberglass	额定转速 Rated Speed (R/min)	风量 Air Capacity M ³ /h/(CFM)	额定功率 Rated Power Kw/HP	电压参数 Voltage Frequency/Phase	尺寸 Complete Size LXHXW(mm)
RTE-1460	1250/(50")	6 玻璃钢	560	44000(26000)	1.1/1.5	380V/220V 50HZ/60HZ 3/1	1850*1490*900
RTE-1060	890/(36")	6 玻璃钢	560	28000(16600)	0.75/1		1420*1100*800

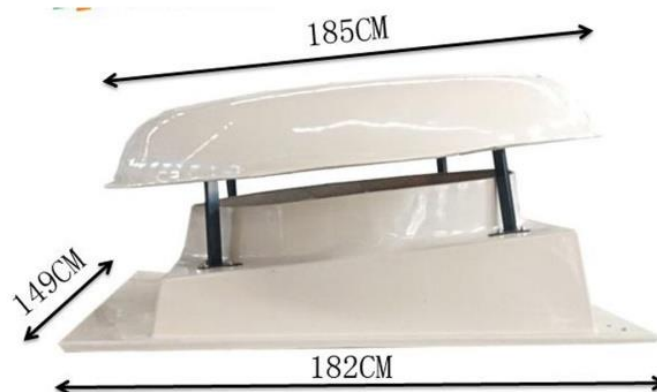

Automatic Roof Ventilator

Features:

One of the most common questions posed in regards to turbine roof vents is why they are effective at all. I deal with this every day. People don't understand how or why having turbine roof vents can work or be an asset. They see that there's a bunch of holes on the roof, which means the heat will escape even more right? Wrong. Let me explain further.

Turbine venting is one way to cool your home without using electricity. Still, the primary function is much more efficient than simply exhausting hot air from your attic- it can keep your home cool in ways you might never have considered before! To help you better

Technical Parameters:



规格(mm)	A(mm)	B(mm)	C(mm)
100	100	150	180
150	150	220	200
200	200	300	240
300	300	430	330
400	400	430	530
450	450	510	590
500	500	600	670
600	600	700	670
800	800	970	720



Authorized Distributor for Bangladesh



HRG ENVIRONMENTAL ENGINEERING

(Ventilation Equipment Division)

Registered Office: Bagbari, 5 No. Ward, Kashimpur, Gazipur, Bangladesh

Dhaka Office: House # 41, Road # 12, Sector # 10, Uttara, Dhaka-1230

Mobile: +88 01713066638

E-mail: hasib@hrg.com.bd, **Website:** www.hrg.com.bd

青州飞腾温控机械有限公司

QINGZHOU FEITENG THERMO - CONTROL MACHINERY CO., LTD

TEL: 86-536-3523210

FAX: 86-536-3523201

Web: www.qz-goodvalue.com

Add: North of Transformer Substation 220000

Volt, Xiankelai Road, Qingzhou, Shandong, China.

电话: 0536-3523210

传真: 0536-3523201

网址: www.feitengwk.com

地址: 山东省青州市王母宫开发区七里街东首